

# PRESSURE REDUCING VALVE - ZDR

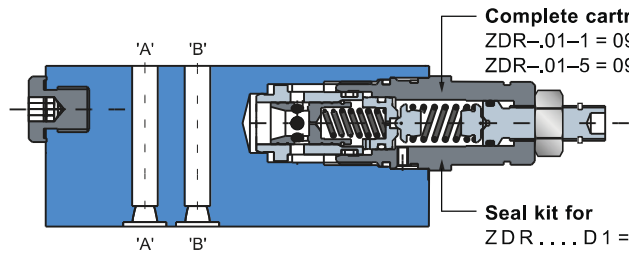

- Operating pressure range
  - ZDR-P 7...70/350 bar
  - ZDR-A / B 7...70/315 bar
- Max. flow 80 l/min
- Viscosity range 10 ... 500 cSt
- Fluid temperature range -18 ... + 60°C
- Pilot oil (P, A, B - T)max. 0.3 l/min



**Complete cartridge for**  
 ZDR-.01-1 = 098-91102-0  
 ZDR-.01-5 = 098-91103-0

**Seal kit for**  
 ZDR....D1 = 098-91184-0  
 ZDR....D5 = 098-91185-0

## ORDERING CODE :

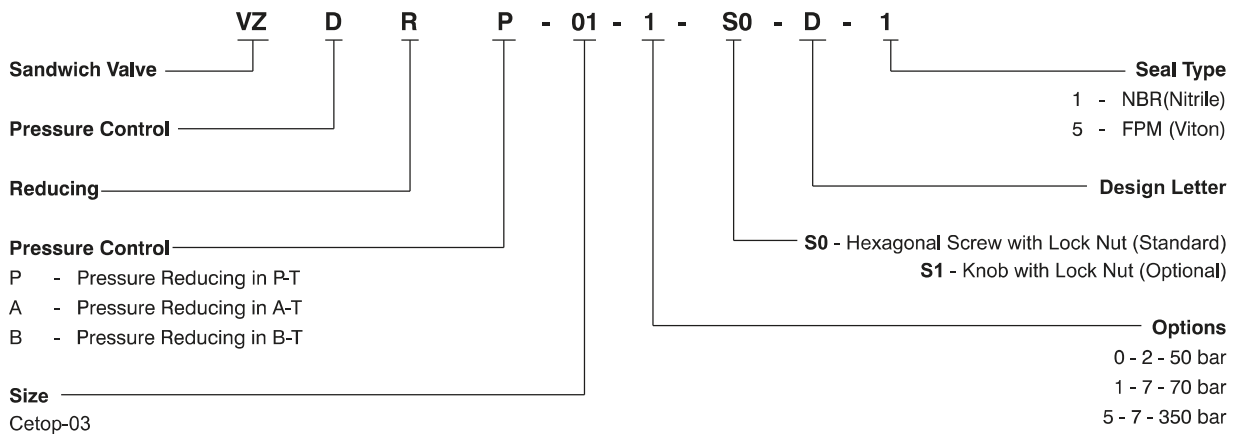

### PRESSURE REDUCING IN P WITH PRESSURE GAUGE PORT

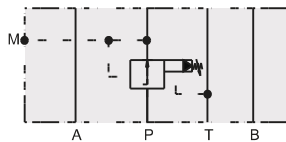

**Model Code:**      **Order No.**  
 ZDR-P01-1-S0-D1    098-91179-0  
 ZDR-P01-5-S0-D1    098-91211-0

1 = 7... 70 bar  
 5 = 7... 350 bar

### PRESSURE REDUCING IN A

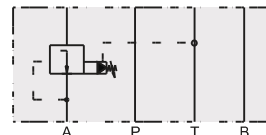

**Model Code:**      **Order No.**  
 ZDR-A01-1-S0-D1    098-91212-0  
 ZDR-A01-5-S0-D1    098-91213-0

### PRESSURE REDUCING IN B

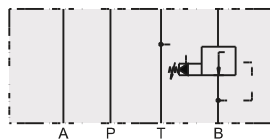

**Model Code:**      **Order No.**  
 ZDR-B01-1-S0-D1    098-91214-0  
 ZDR-B01-5-S0-D1    098-91215-0

1 = 7... 70 bar  
 5 = 7... 315 bar

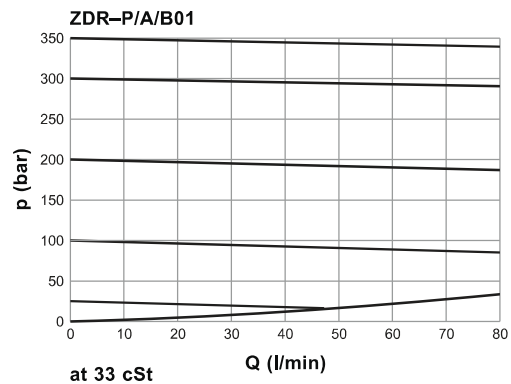

**INSTALLATION - 1.6kg**

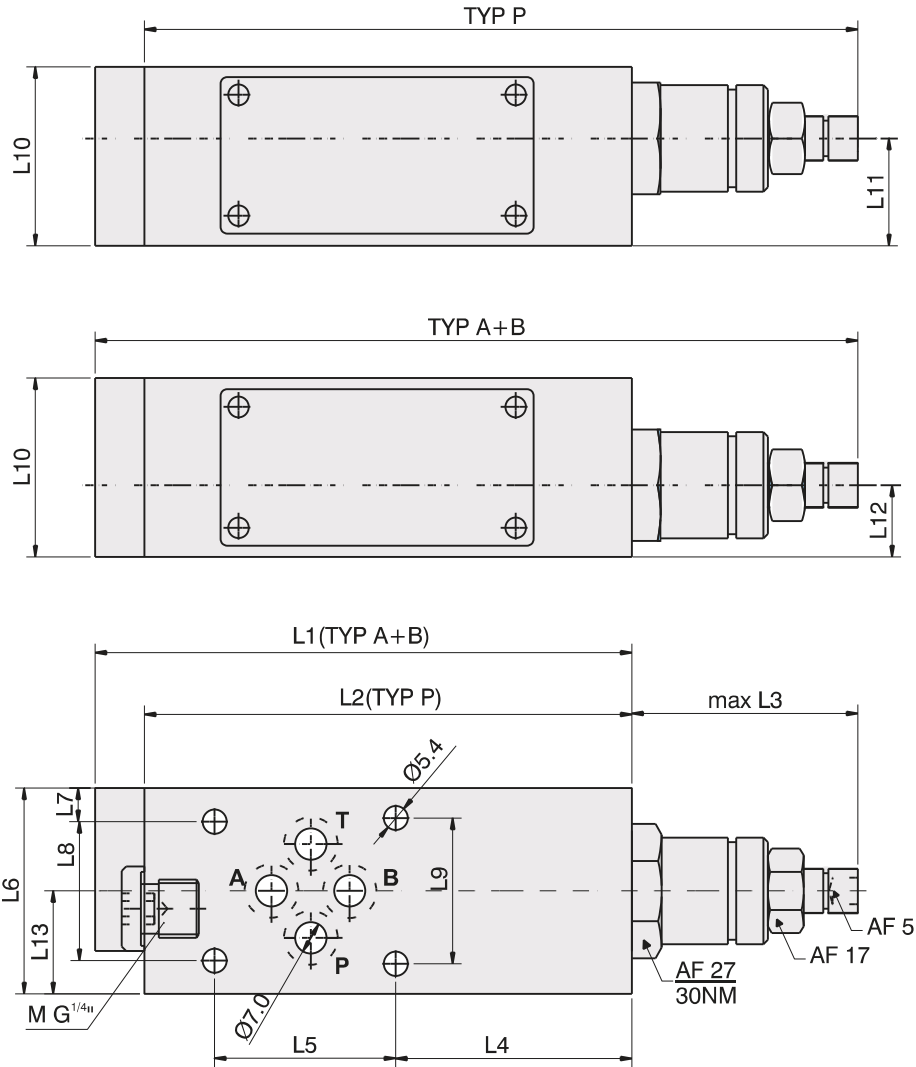

UNITS	L1	L2	L3	L4	L5	L6	L7	L8	L9	L10	L11	L12	L13
mm	120.0	109.0	50.5	52.9	40.5	46.0	7.50	31.0	32.5	40.0	24.0	16.0	23.0
in	4.72	4.29	1.99	2.08	1.59	1.81	0.29	1.22	1.28	1.57	0.94	0.63	0.90

**SERVICE INFORMATION:**

MODEL CODE	SPARE PART NO.	DETAILS
VZDR-01-1	V098-91102-0	CARTRIDGE
VZDR-01-5	V098-91103-0	CARTRIDGE
VZDR.....D1	V098-91184-0	SEALKIT
VZDR.....D5	V098-91185-0	SEALKIT