



4/3, 4/2 and 3/2 Directional Valve with Wet-pin AC or DC Solenoid

2.14

Type WE 10...L5X

Size (NG) 10
Up to 350 bar
Up to 150 L/min



Contents

Function and configurations	02-03
Ordering code	04
Symbols	05
Technical data	06
Electrical data	06
Characteristic curves	07
Performance limits	07
Unit dimensions	08

Features

- Direct operated directional spool valve with solenoid operation
- Porting pattern according to DIN 24 340 Form A, ISO 4401, and CETOP-RP121H
- Wet-pin DC solenoids with detachable coil (AC voltages possible via a rectifier)
- Solenoid coil can be rotated through 90°
- The coil can be replaced without opening the pressure-tight chamber
- Adjustable spool switching time, optional

Function and configuration

WE10-L5X directional valves are solenoid operated directional spool valves. They control the start, stop and direction of flow with the additional option of adjusting the spool switching time.

These directional valves basically consist of the housing (1), one or two solenoids (2), the control spool (3), as well as one or two return springs (4).

In de-energized condition, the control spool (3) is held in the central position or in the initial position by the return springs (4) (except for valves without spring "O").

If the wet-pin electronic solenoid (2) is energized, the control spool (3) moves out of its rest position into the required end position. In this way, the required direction of flow according to the selected symbol is released. After the electronic solenoid (2) has been switched off, the control spool (3) is pushed back into its central position or into its initial position (except for valves with "OF" detent and valves without type "O" spring). A manual override (6) allows for the manual switching of the valve without solenoid energization.

To ensure proper functioning, make sure that the pressure chamber of the solenoid is filled with oil.

Adjustable spool switching time (only with DC solenoids)

The optional installation of a throttle screw (7) or orifice (8) -see below - offers the possibility of increasing the switching time to 100ms or more for WE10-L5X series of 5-chamber directional valves. The switching time is influenced by factors such as pressure, flow rate and oil viscosity, depending on the situation of installation. When the main spool (3) is in the neutral or initial position, the spring chambers at both sides are filled with oil when reversing the spool, the oil in the spring chamber flows through the connecting channel (9) to move the spool forward. The adjustment time can be adjusted according to actual needs by limiting the connection channel (9) (such as screwing in the throttle screw or installing the orifice to reduce the overcurrent area).

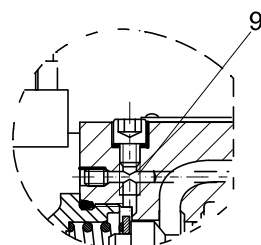
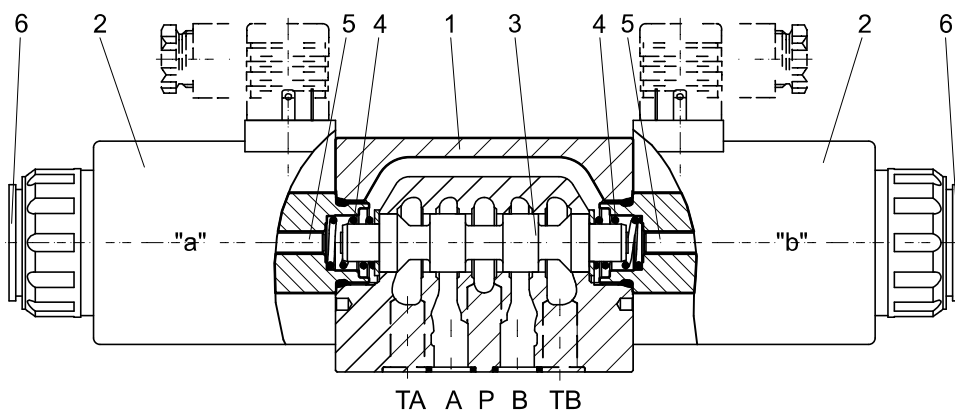

Without throttle screw/
without orifice

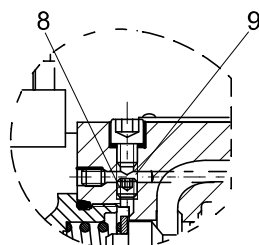

With orifice 'A0.'

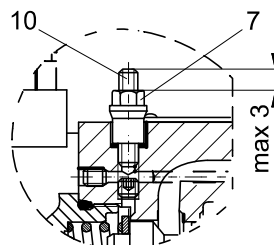

With throttle crew 'C'

Function and configuration

Type WE10.L5X/O...

(only possible with symbols A, C and D)

This version is a directional valve with 2 switched positions and 2 solenoids without detent. There is no defined spool position in the de-energized condition.

Type WE10.L5X/OF...(Impulse spool)

(only possible with symbols A, C and D)

This version is a directional valve with 2 detented switched positions and 2 solenoids. Thus, the spool is held in the last switched position, permanent energization of the solenoid is not required.

Throttle insert

(Type 4WE10.L5X/.../B...)

The use of a throttle insert is required, due to the operating conditions. Flows can occur during the switching process which are larger than the performance limits of the valve allow.

The orifice is to be inserted into the P channel of the directional valve.

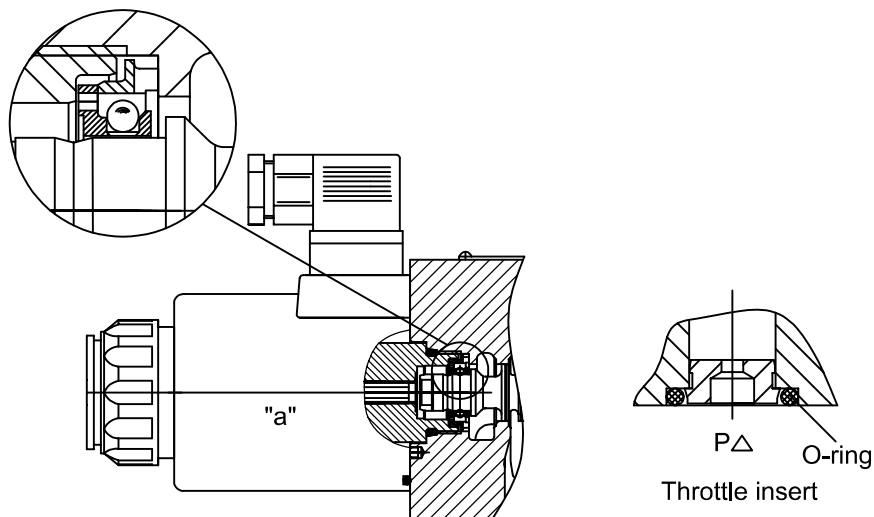

Type:WE10.L5X/OF ... (Impulse spool)

Ordering code



3 work ports
(Symbol A, B) = 3
4 work ports = 4

Solenoid valve

Nominal size 10 =10

Symbols

Series L50 to L59 =L5X
(L50 to L59: unchanged installation
and connection dimensions)

With spring return = No code

Without spring return = O

Without spring return with detent = OF

High-performance solenoid = E

12VDC = G12

24VDC = G24

With manual override =N

Square plug = Z4

Square plug with indicator light = Z5L

Without mating connector, with DT04-2P connector = K7

Without mating connector, with connector
according to DIN EN 175301-803 = K4

Standard= No code

T06= Minimum
(to be selected in case of
reduced leakage → higher
level of oil cleanliness
recommended)

T12= Increased
(to be selected in case of a
hydraulic fluid/environment
temperature difference > 25 K
→ increased internal leakage)

No code= NBR seals

V = FKM seals

No code= Without throttle insert

B08= Throttle ϕ 0.8 mm

B10= Throttle ϕ 1.0 mm

B12= Throttle ϕ 1.2 mm

B15= Throttle ϕ 1.5 mm

B20= Throttle ϕ 2.0 mm

B25= Throttle ϕ 2.5 mm

B30= Throttle ϕ 3.0 mm

No code= Without switching
time adjustment

C = With throttle screw

A06= Throttle ϕ 0.6 mm

A08= Throttle ϕ 0.8 mm

A10= Throttle ϕ 1.0 mm

02

Symbol

Transition position

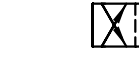
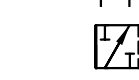
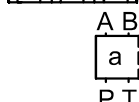
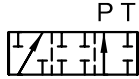
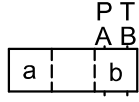
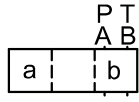
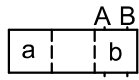

Spool valve symbol

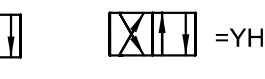
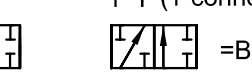
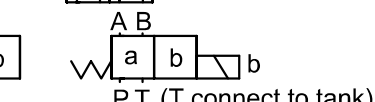
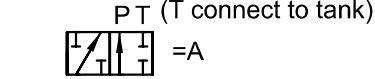
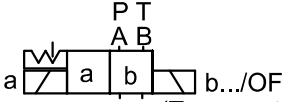
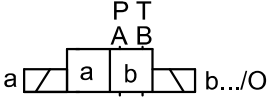
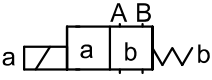

Transition position

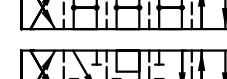
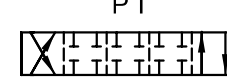
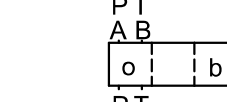
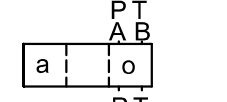
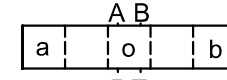

Spool valve symbol

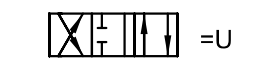
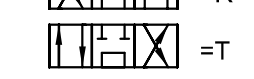
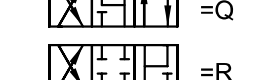
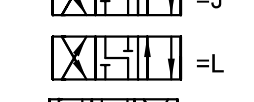
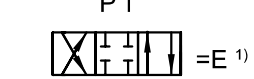
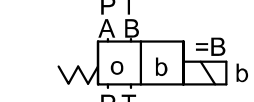
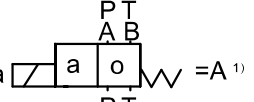
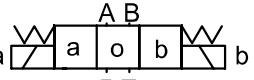

¹⁾ Example: Spool E with switched position "a". Ordering detail ..EA..

Technical data

Fixing position		Optional	
Ambient temperature range		°C	
		– 30 to + 50 (with NBR seals)	
		– 20 to + 50 (with FKM seals)	
Weight	Valve with 1 solenoids	kg	4.3 (DC)
	Valve with 2 solenoids	kg	5.9 (DC)
Max.operating pressure	Port A,B,P	bar	350
	Port T	bar	210 (DC), With symbols A and B, port T must be used as a drain port, if the operating pressure is higher than the permissible tank pressure.
Maximum flow		L/min	150
Pressure fluid		Mineral oil (HL, HLP) to DIN 51 524, suitable for NBR and FKM	
		Phosphate ester, suitable for FKM	
Pressure fluid temperature range		°C	
		– 30 to + 80 (with NBR seals)	
		– 20 to + 80 (with FKM seals)	
Viscosity range		mm ² /s	2.8 to 500
ISO code cleanliness class		Maximum permissible degree of contamination of the pressure fluid is to ISO 4406 (C) class 20/18/15	

Electrical data

Voltage type		DC	
Available voltage		V	12, 24
Voltage tolerance (nominal voltage)		%	Super performance solenoid: +10 ~ -15
Power consumption		W	39
Duty		Continuous	
Switching time to ISO 6403 (without switching time adjustment)	ON	ms	45 to 60
	OFF	ms	20 to 30
Switched frequency		cycles/h	Up to 15000
Protection to DIN 40 050		Z4, Z5L, K4:IP65; K7:IP67	
Maximum coil temperature		°C	+150

When connecting the electrics, the protective conductor (PE $\frac{1}{2}$) must be connected according to the relevant regulations.

Note:

The solenoid coils must not be painted. Actuation of the manual override is only possible up to a tank pressure of approx. 50 bar [725 psi]. The simultaneous actuation of 2 solenoids of one valve must be ruled out!

Characteristic curves (Measured with HLP46, $\vartheta_{oil} = 40^{\circ}\text{C} \pm 5^{\circ}\text{C}$ [104 \pm 9 $^{\circ}$ F])

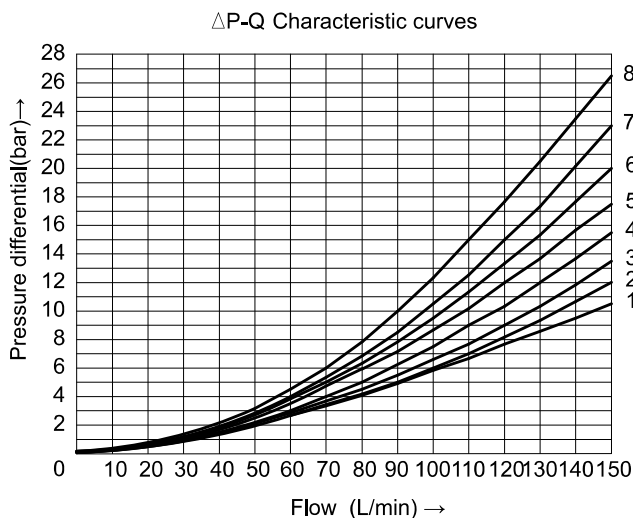

Spool symbol	Flow direction				
	P to A	P to B	A to T	B to T	P to T
A	4	4	-	-	-
B	4	5	-	-	-
C, J, Y, YH	2	3	5	7	-
D	2	2	5	7	-
E	3	3	6	7	-
F	1	3	3	8	4
G	4	5	6	8	7
H	1	1	6	8	7
L	3	3	5	7	-
P	3	1	5	6	5
R	3	4	5	6	-
U	2	2	5	7	-
DE	3	-	-	6	-
YE	-	3	6	-	-

02

Performance limits (Measured with HLP46, $\vartheta_{oil} = 40^{\circ}\text{C} \pm 5^{\circ}\text{C}$ [104 \pm 9 $^{\circ}$ F])

Due to the flow forces acting within the valves, the admissible performance limits may be considerably lower with only one direction of flow (e.g. from P to A while port B is blocked)!

In such cases of application, please consult us! The switching performance limit was established while the solenoids were at operating temperature, at 15% undervoltage and without tank preloading.

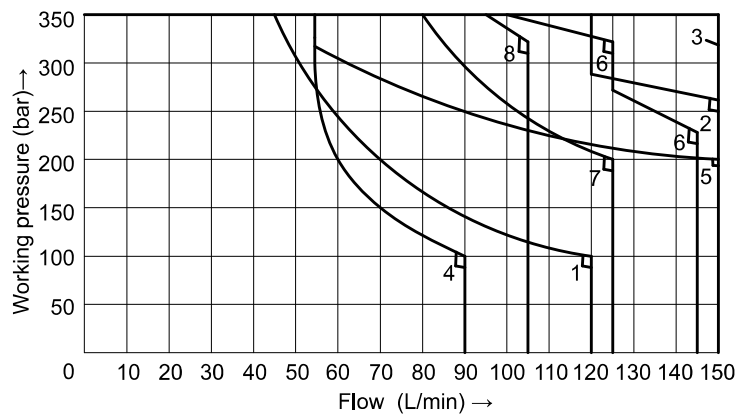

Curve	Symbol
1	A, B
2	C, D, Y, YH
3	E
4	F, P
5	G
6	H, L, U
7	J
8	R

Unit dimensions

(Dimensions in mm)

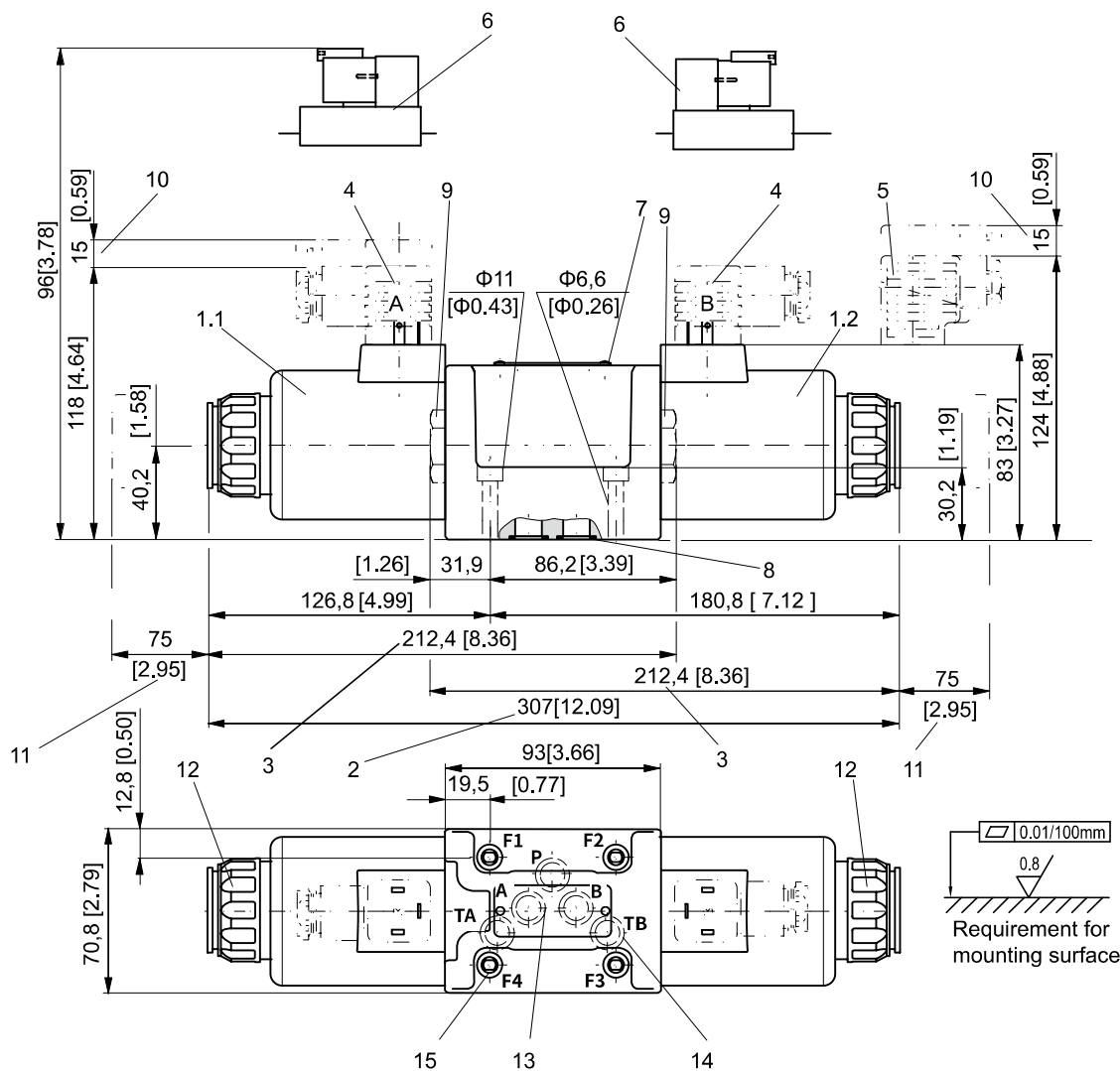

- 1.1 Solenoid "a"
- 1.2 Solenoid "b"
- 2 Dimension of 3-position valves
- 3 Dimension of 2-position valves
- 4 Connector without indicator light according to DIN EN 175301-803
- 5 Connector with indicator light according to DIN EN 175301-803
- 6 DT04-2P Deutsch connector
- 7 Name plate
- 8 Identical seal rings for ports A, B, P, TA and TB
- 9 Plug screw for valves with one solenoid
- 10 Space required to remove connector
- 11 Space required to remove coil
- 12 Securing nut, tightening torque $M_A = 6+2 \text{ Nm}$ [4.43 +1.48 ft-lbs]
- 13 Porting pattern according to ISO 4401-05-04-0-05 and DIN 24340 A10
- 14 TB can be used in connection with separately produced bore
- 15 Valve fixing screws: 4 hexagon socket head cap screws, metric ISO 4762-M6×40-10.9
Tightening torque $M_A = 15.5 \text{ Nm}$ [11.4 ft-lbs] ± 10 %
With different friction coefficients, the tightening torques can be adjusted accordingly!

It must be ordered separately, if connection plate is needed. Type:
 G 66/01 (G3/8) G 66/02 (M18×1.5)
 G 67/01 (G1/2) G 67/02 (M22×1.5)
 G 534/01 (G3/4) G 534/02 (M27×1.5)

Notice:

- 1. Deviating from ISO 4401, port T is called TA and port T1 is called TB in this data sheet.
- 2. The dimensions are nominal dimensions which are subject to tolerances.